

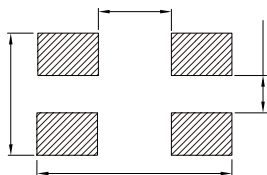

- Exclusive square type closed magnetic core designed as an exclusive core is used, so it can be small while maintaining the same features.
 - Low profile design makes it optimal for surface mounting.
 - Excellent impedance characteristics, making it great for suppressing common mode noise.
 - Maximum 15A can be used in 125°C environments.
 - Operating temperature range: -40 to +125°C
 - AEC-Q200 qualified
 - Quantity: 1500pcs
-
- Measures against common mode noise in power lines for various DC power lines, multimedia devices, and various electronic devices

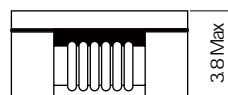

Part No	Z @ 100 MHz Min. (Ω)	Z @ 100 MHz Typ. (Ω)	I _R Max. (A)	R _{DC} Max. (m Ω)	V _{DC} Max. (Volts)	IR Min. (M Ω)
BCMA7060-700Y	40	70	15	5	80	10
BCMA7060-141Y	100	140	9.0	10	80	10
BCMA7060-301Y	225	300	5.0	10	80	10
BCMA7060-501Y	400	500	5.0	10	80	10
BCMA7060-701Y	500	700	4.0	15	80	10
BCMA7060-102Y	800	1000	3.0	17	80	10
BCMA7060-132Y	910	1300	3.0	20	80	10
BCMA7060-272Y	2000	2700	1.0	63	80	10
BCMA7060-302Y	2500	3000	0.9	75	80	10

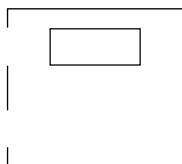
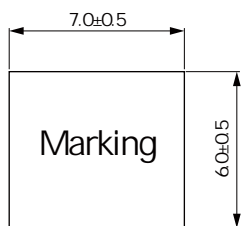
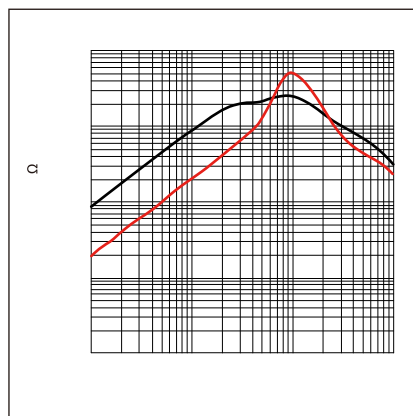
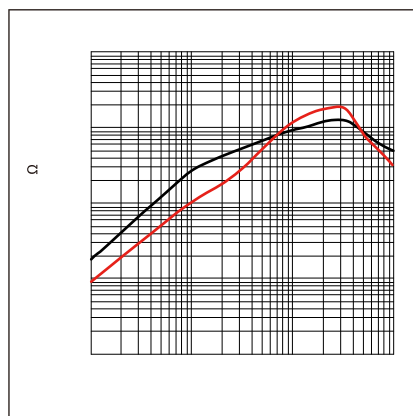
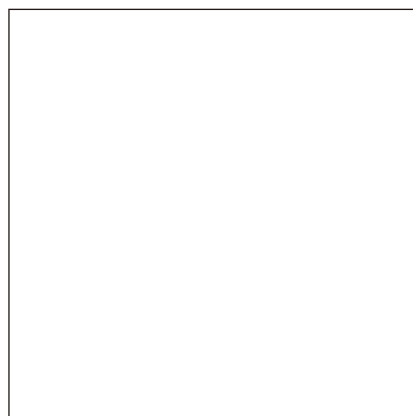
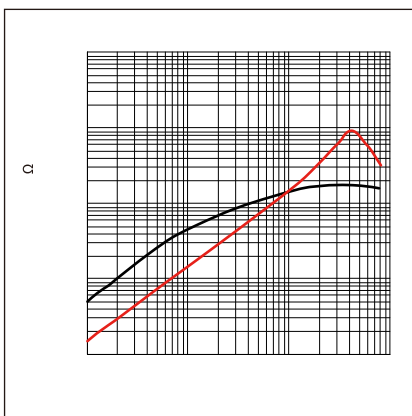
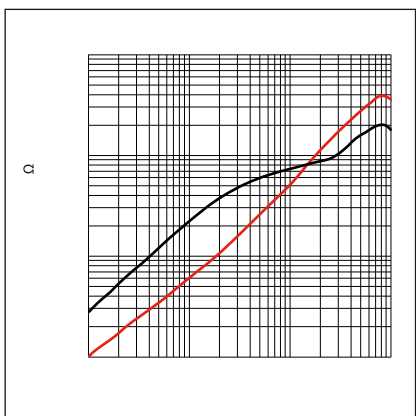

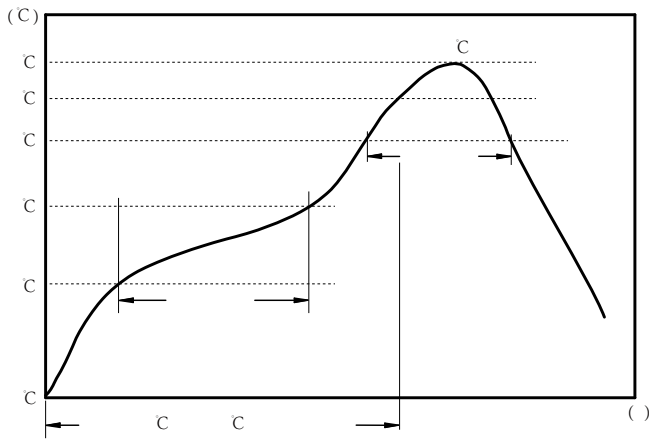

C
C
C

:

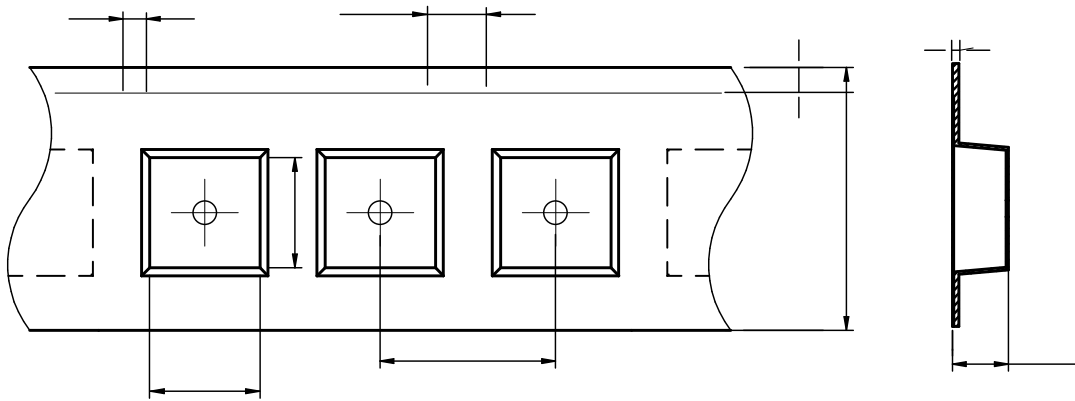

45? 3) ("	(Z\$' f " z#) z) f " z#	#z' f " z#	&z' f " z#	#\$z' f " z#	#(z' f " z%	%z(f " z#	#z) ' f " z#	" z&" f " z' "

? Sd] [Y	Bd] f [Y ;_ bWWS' UW'i
-----------	-------------------------





:

•

•

•

•

•

•

•

•

•

•

•

•

•